

# TODAS AS REDES

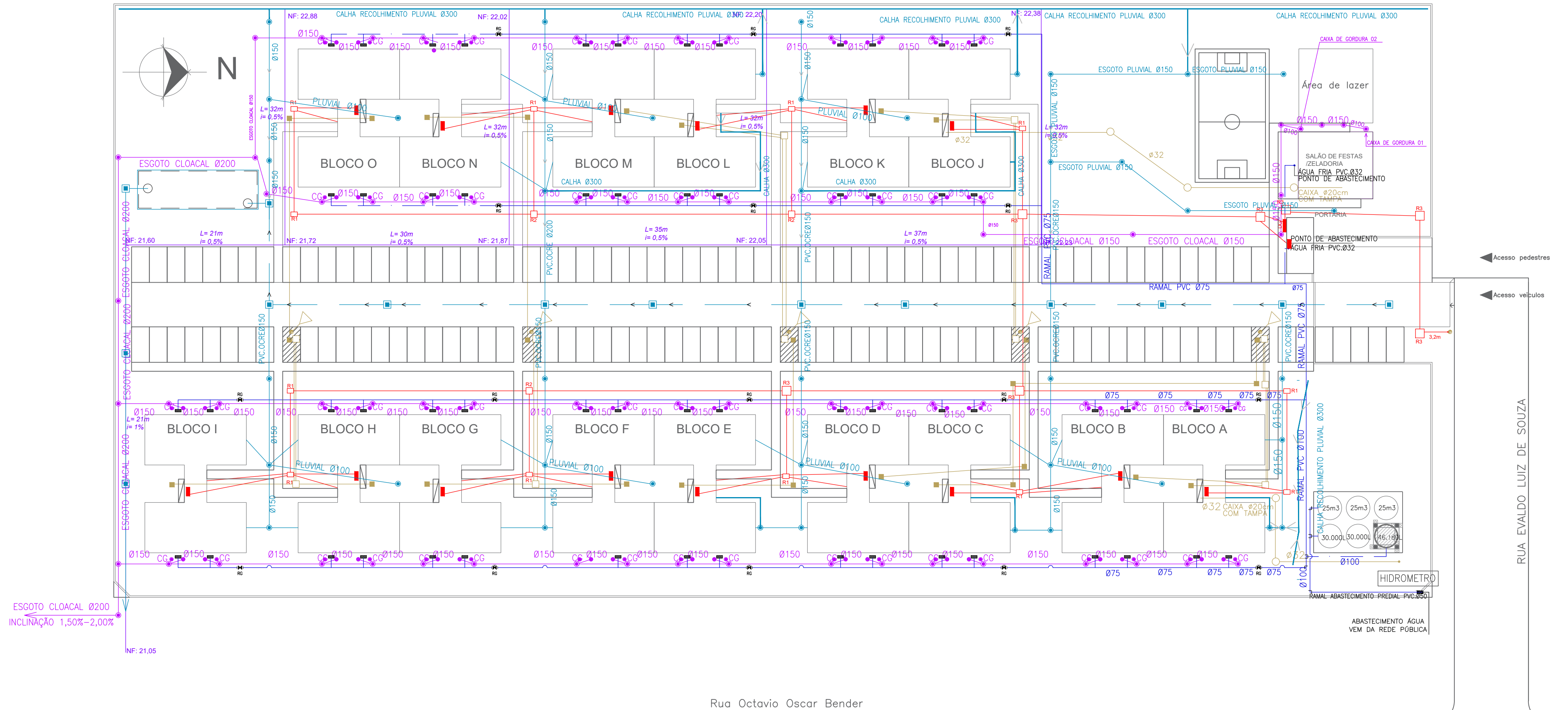

# REDE CLOACAL

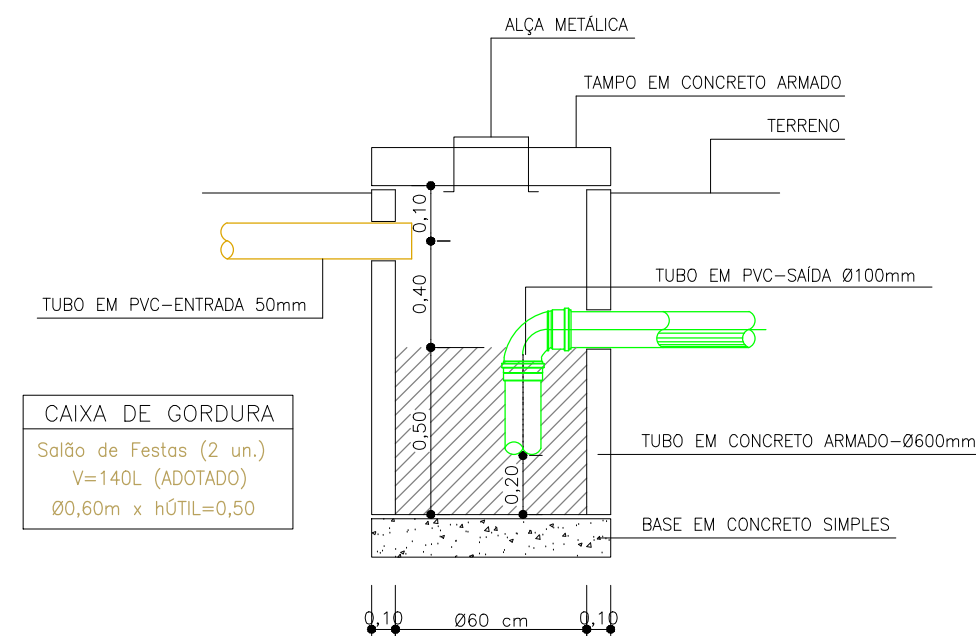
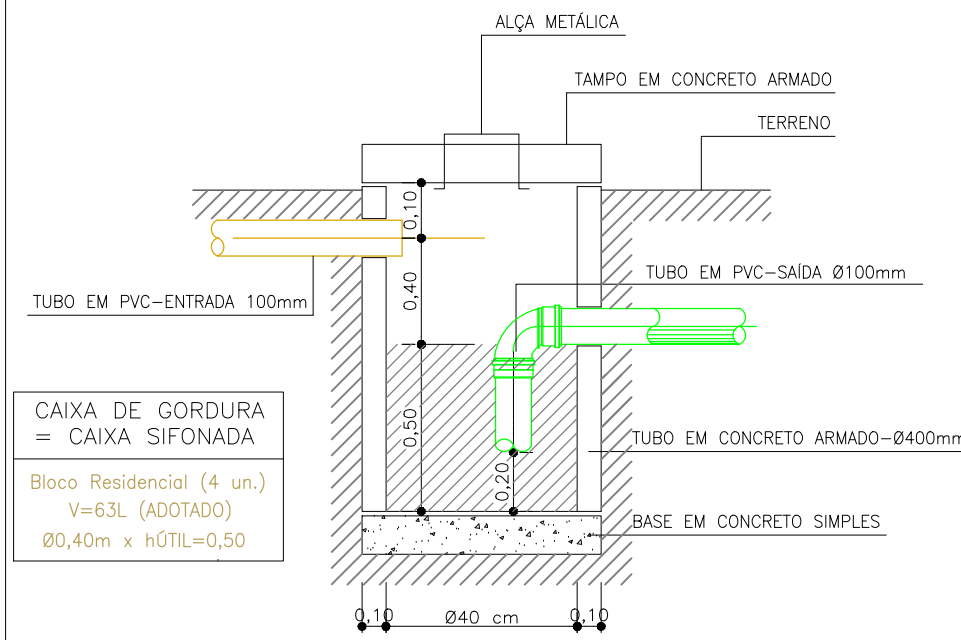
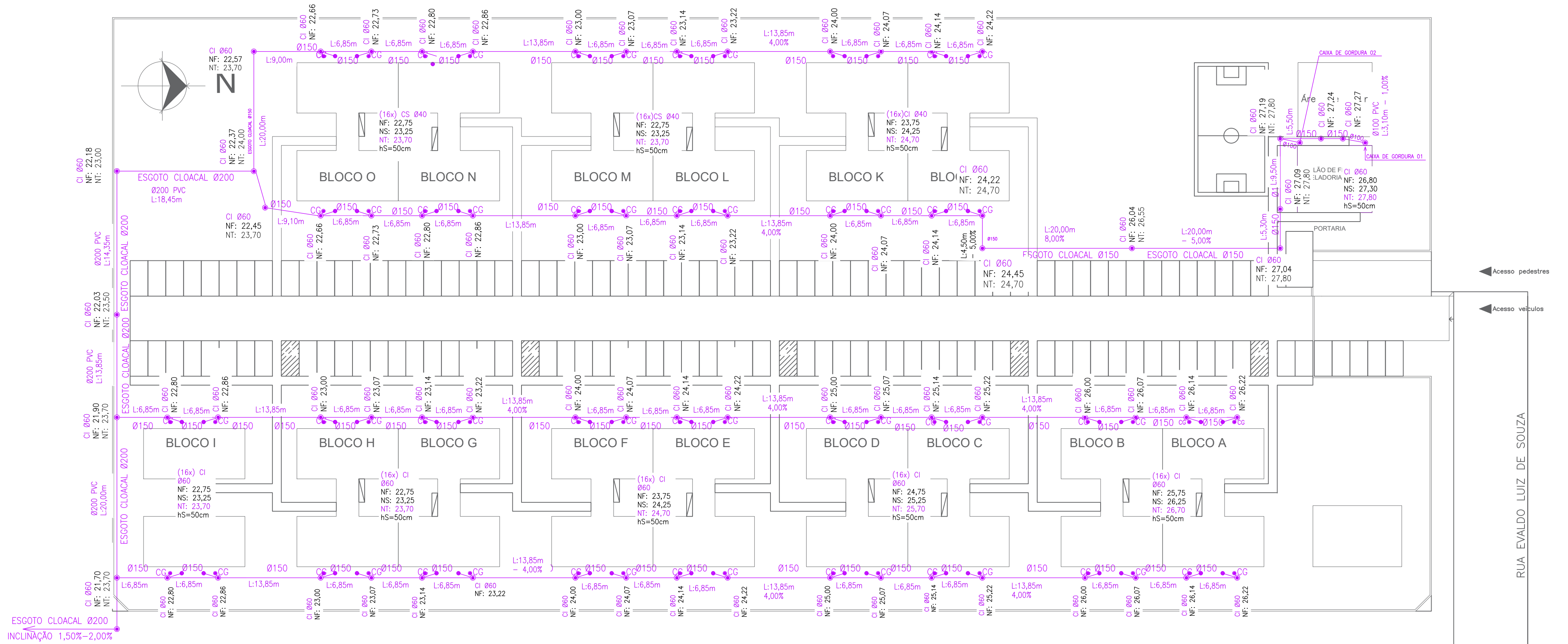

OBS 1: as caixas de gordura e inspeção junto aos blocos tem cotas e tamanhos conforme descrição no centro de cada bloco.  
 OBS 2: as caixas de passagem conectadas as de gordura e inspeção de cada bloco, tem mesmo nível de tampa destas.  
 Demais caixas de passagem conforme descrição de nível junto a essas.

# REDE PLUVIAL

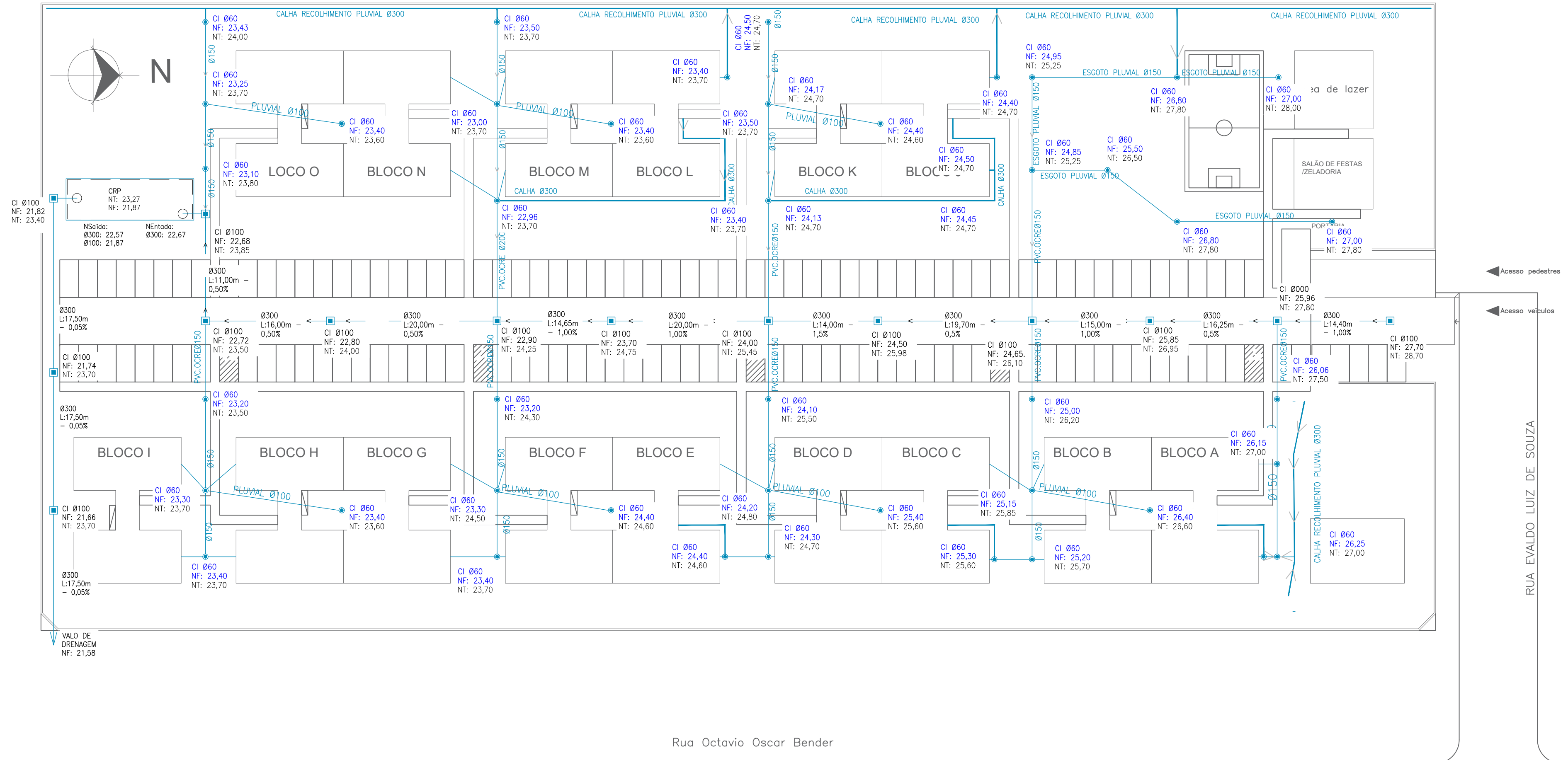

# REDE DE ÁGUA FRIA

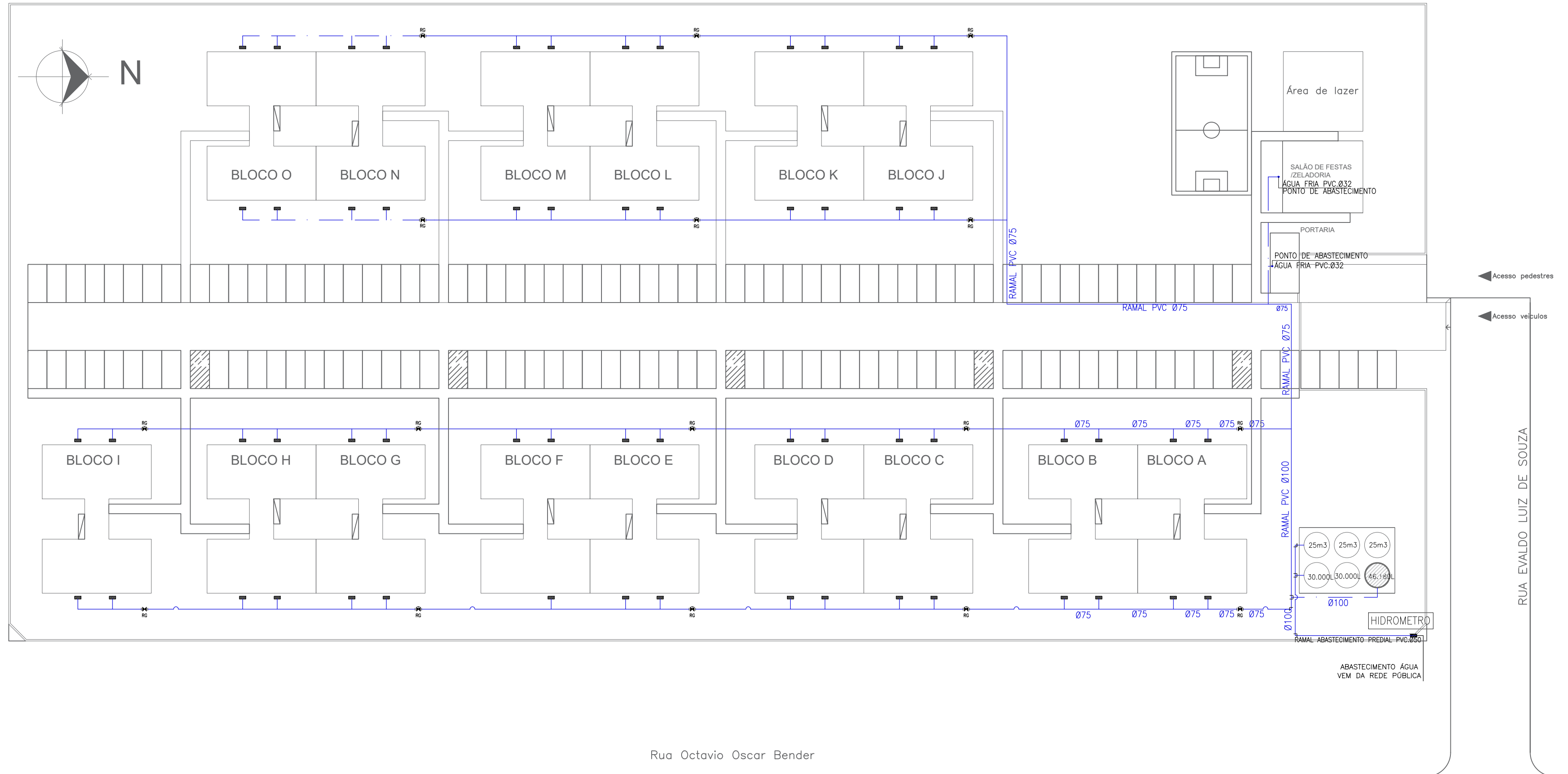

REDE DE ÁGUA FRIA  
 QUANDO NÃO INDICADO O DIÂMETRO  
 CONSIDERAR PVC.Ø50

# REDE TELEFONE E PORTEIRO

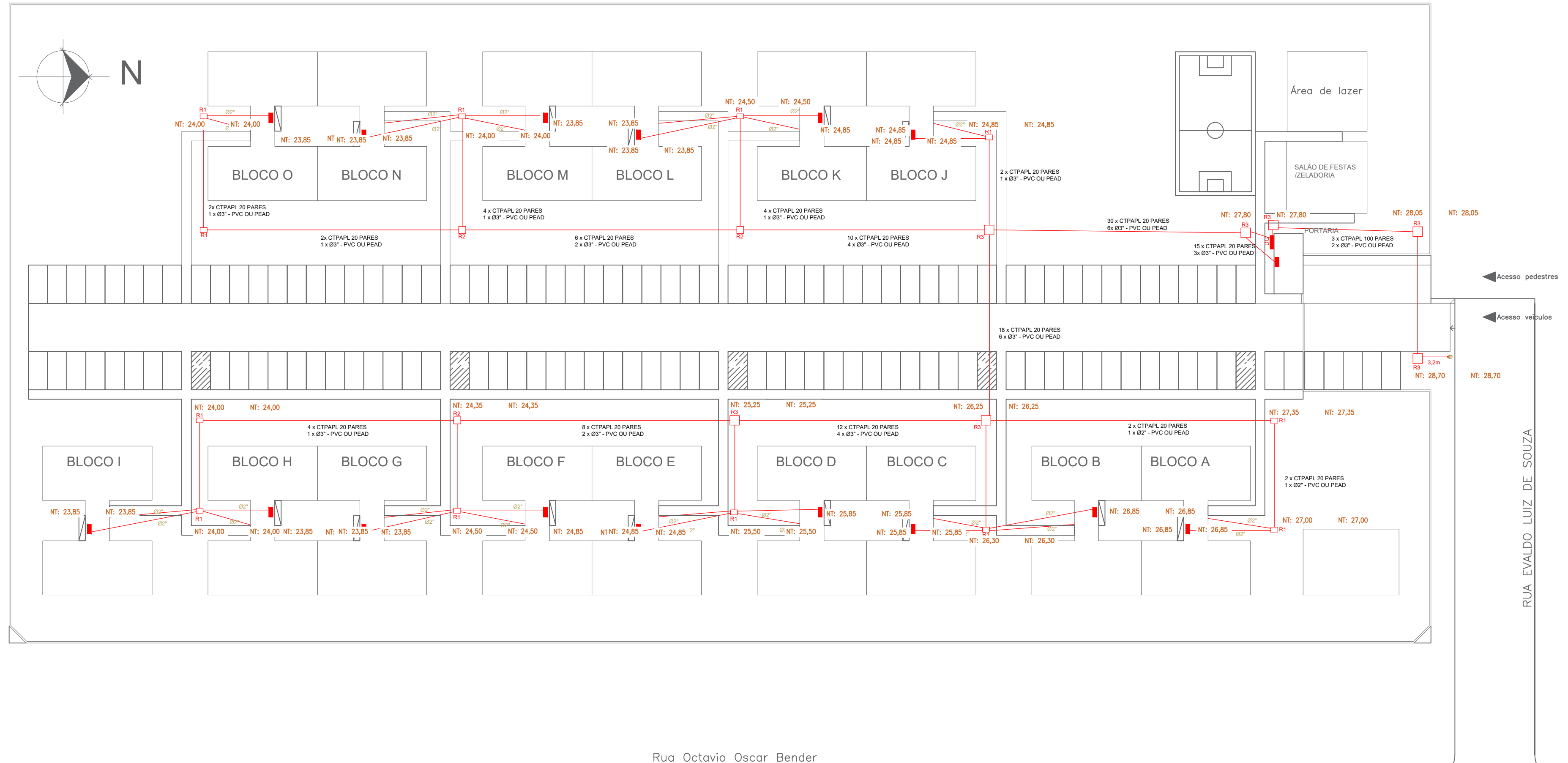

Rua Octavio Oscar Bender



# REDE ELÉTRICA

